

Varenummer: 203160M16125B1U

Beskrivelse: E+G Justerfod
GN 31-60-M16-125-B1-U

Note: U Uden møtrik, sekskant i toppen, spændeflade i bunden

Mål

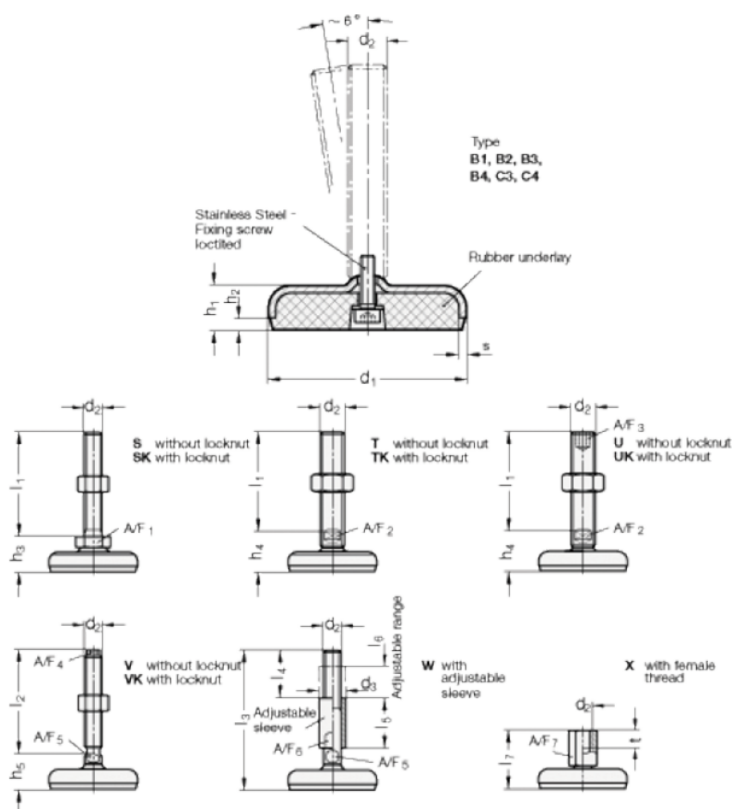

A/F2	= 12	s = 3
A/F3	= 8	
d1	= 60	
d2	= 16	
h1	= 16	
h4	+4.0/0 = 30	
l1	= 125	